

SPECIFICATION FOR APPROVAL

產品確認書/製品仕様書

FILE SERIAL NO./檔序號:	XSG20240622001-T01
CUSTOMER / 客 戶:	
ARTICLE / 品 名:	SWITCHING POWER SUPPLY/CHARGER
MODEL NO. / 機種型號:	XSG2522500EU
PARAMETER / 規 格:	25.2V2.5A
CERTIFICATE/認證:	CB、CE
ISSUE DATE / 發行日期:	2024/6/22

Please to sign back after you confirm

承認書確認後請回簽一份

この仕様書をご確認とご署名の上、対象の営業窓口にご返信いただきますようお願い致します。

CUSTOMER AUTHORIZED 客戶確認		
Approved by	Checked by	Prepared by

SUPPLIER AUTHORIZED 供方確認		
Approved by	Checked by	Prepared by
李麗敏	賀子豐	張文娟

*感謝您的支持，我們十分珍惜每次合作機會

*Thank you for your support, we will treasure the opportunity to cooperate with you

Rev.版本	Description of change/ 變更內容描述		Changed Date 日期	Approved
	Before(變更前)	After/變更後		
A	Original Release(初次發行)		2024/6/22	張文娟



* Make practical and safe power supply, Be enterprise with honesty and responsibility

* 提供實用安全的電源，做誠信負責的企業

* 實用的、安全な電源を提供し、誠実と信用、責任を持つ企業。

ELECTRICAL PERFORMANCE / 電器性能

1.SAFETY STANDARD / 安規標準

- 1.1 The green mode power supply shall be certified by the following international regulatory standards: 充電器應符合下列的國際標準：

Certificate 證書	Country 國家	Standard/安規標準	Certificate 證書	Country 國家	Standard/安規標準
<input type="checkbox"/> UL/cUL	USA/CA 北美	UL62368-1; CAN/CSA C22.2 No62368-1 UL1310-1	<input type="checkbox"/> FCC	USA	FCC Part 15 Subpart B
<input type="checkbox"/> LVD/ GS	Germany 德國	EN62368 EN60335	<input checked="" type="checkbox"/> CE	Europe 歐洲	EN55032;EN55035;
<input checked="" type="checkbox"/> CB	Global 全球	IEC62368;IEC61558; IEC60335 IEC60601	<input type="checkbox"/> KC	Korea 韓國	K60950-1
<input type="checkbox"/> PSE	Japan 日本	J62368-1(2020) J3000(H25) J55032(H29) J60335-1	<input type="checkbox"/> SAA/RCM	AU 澳洲	AS/NZS 62368.1:2018
<input type="checkbox"/> CCC	CN 中國	GB 17625.1-2012;GB 4943.1-2011;GB/T 9254- 2008	<input type="checkbox"/> LVD / UKCA	Eu / UK 歐盟 英國	EN62368,BS EN 62368 EN61558

2.INPUT FEATURE / 輸入特性

- 2.1 INPUT VOLTAGE RANGE: 90Vac to 264Vac. 輸入電壓範圍可以從90Vac到264Vac.
- 2.2 RATED INPUT VOLTAGE: 100Vac to 240Vac. 額定輸入電壓從100Vac到240Vac.
- 2.3 INPUT FREQUENCY RANGE: 47Hz to 63Hz. 輸入頻率範圍從47Hz到63Hz.
- 2.4 INPUT CURRENT: 1.3A max.&100-240Vac. 最大輸入電流 1.3A (輸入條件100-240Vac)
- 2.5 INRUSH CURRENT: 35A max. at 100-240Vac input for a cold start at 25°C.在准開機條件下，最大浪湧電流不超過35A (輸入條件100-240Vac).
- 2.6 EFFICIENCY: higher than 87% at 100-240Vac input and output full load. 效率高於87% (輸入100-240Vac 和輸出滿載條件)。
- 2.7 No-Load Input Power Dissipation/輸入空載功率損耗: Input 115Vac or 230Vac,output no load, the input power loss is less than 0.5W. 輸入115/230V交流，在空載時，輸入功耗小於0.5W.

3.OUTPUT/輸出特性

Charging Status 充電狀態	Charging Stage 充電階段	Output current 輸出電流(A)	Output voltage 輸出電壓(V)	LED indicator 指示燈
1.Charging 充電中	Constant Current 恒流	2.5A±0.2A	15V-25.2V±0.2V	Red
	Constant Voltage 恒壓	2.5A >0.3A	25.2V±0.2V	Red
2.Charged full 充滿	Trickle Charging 涓流	0.3A >0	25.2V±0.2V	Green

4.Work Status of LED indicator/LED燈工作狀態顯示

No load output:Green Light 空載輸出:綠燈



In Process of Charging:Red Light 充電中:紅燈



Charged Full: Green Light 充滿:綠燈



EDITION	A	PAGE	3/10
----------------	----------	-------------	-------------

5.CHARGING CURVE/充電曲線圖:

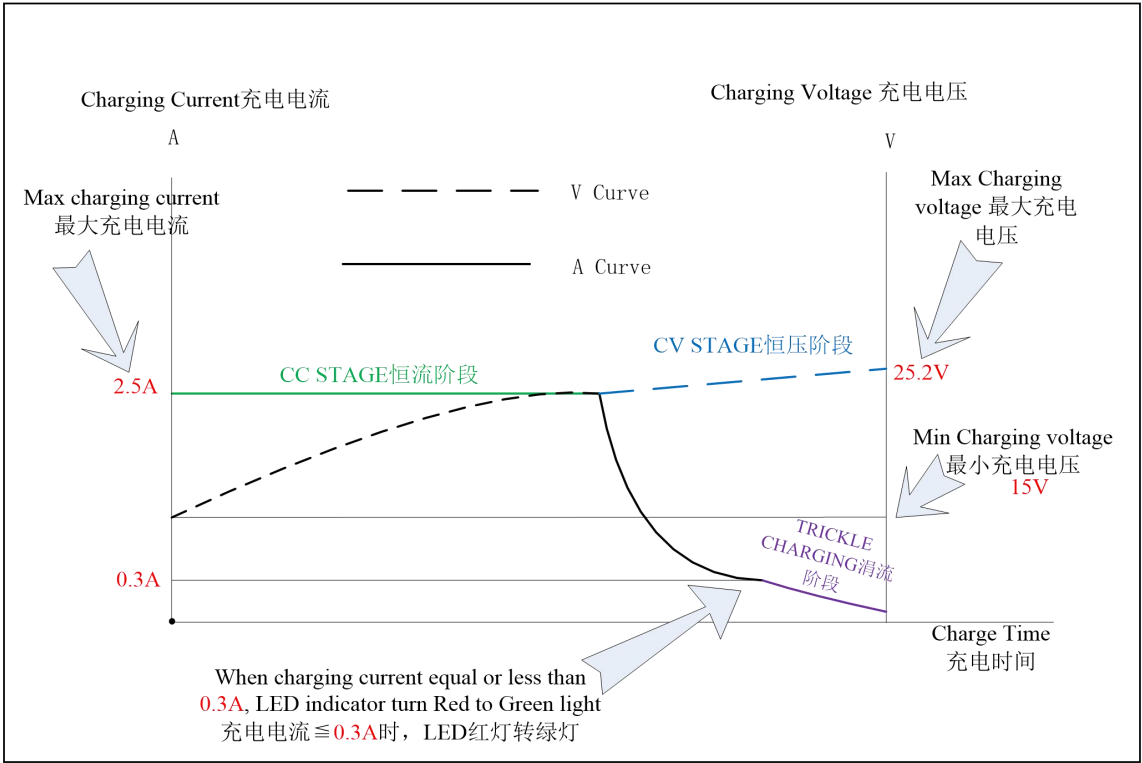

6.PROTECTION FEATURE / 保護特性

6.1 OVER-CURRENT PROTECTION / 過電流保護:

The green mode power supply shall be hiccup when any output operating in overload condition(set@ Max load 100~180%) under any line condition for an indefinite period of time.The power supply shall be self-recovery when the fault condition is removed. 在任何時候任何輸入條件，當輸出操作在超載條件最大充電器的（100~180%）時，充電器將進入打嗝模式，當故障被移走後，充電器要能自動恢復到正常

6.2 SHORT-CIRCUIT PROTECTION / 輸出短路保護:

The power supply shall be hiccup and no damage shall occur when any output operating in a short circuit condition under any line condition for an indefinite period of time. The power supply shall be self-recovery when the fault condition is removed. 在任何時候，任何輸入條件下，當輸出操作在短路情況下，充電器將進入打嗝模式，當故障消失後，充電器要能自動恢復正常。

6.3 REVERSE POLARITY PROTECTION/防反接保護(Optional)

6.3.1. To use Fool-Proof type DC plug.建議使用防呆式設計的DC連接頭

6.3.2.When Connect wrong polarity, the charger will be self-recovery when fault condition is removed. this function is optional, customer could choose it in according to real requirement.

EDITION	A	PAGE	4/10
---------	---	------	------

ELECTRICAL PERFORMANCE / 電器性能

當錯誤操作，反向連接時，充電器進入保護狀態，直到故障解除。此為選配功能，客戶可根據實際情況選擇。

7. ENVIRONMENTAL CONDITIONS / 環境條件

7.1 OPERATING / 操作條件：

The power supply shall be capable of operating continuously in any mode without performance deterioration in the following environmental conditions. 在下列環境條件下，充電器要能夠連續操作在各種模式，且不能造成性能的退化。

7.1.1 **Operation Temperature: -20°C ~ 40°C 工作溫度: -20°C ~ 40°C**

7.1.2 **Relative Humidity: 10% ~ 90% 相對濕度: 10% ~ 90%**

7.1.3 **Vibration: 1.0mm, 10-25Hz, 15 minutes per cycle for each axis (X, Y, Z)**

7.1.4 **Cooling: The power supply will operate with convection cooling. Blocking of vents must not cause damage to The power supply. 充電器將操作在對流冷卻的環境下，即使將通風口阻塞充電器也不允許有任何損傷發生。**

7.2 NON-OPERATING / 非操作條件：

The power supply shall be capable of withstanding the following environmental conditions extended periods of time, without sustaining electrical or mechanical damage and subsequent operational deficiencies:

充電器要能夠長期的經受下列的環境條件，且不允許有電氣級機械方面的損傷和併發的操作的缺失

7.2.1 **Storage Temperature: -30°C ~ 70°C 儲存溫度: -30°C ~ 70°C**

7.2.2 **Relative Humidity: 10% ~ 90% 相對濕度: 10% ~ 90%**

7.2.3 **Color of case and cable / 外殼及線材顏色: Black / 黑色**

7.2.4 **Vibration and Shock / 振動和衝擊**

The power supply shall be designed to withstand normal transportation vibration per MIL-STD-810D, method 514 and procedures X, as it is mounted in the chassis assembly and packed for shipping.

充電器出貨的包裝設計，均要能承受正常運輸的振動，並符合MIL-STD-810D方法514和程式X。

7.2.5 **Dropping Testing / 跌落試驗：**

X-Y-Z direction 100cm, one time with each direction

X-Y-Z三個方向高度1m每個方向各一次。

8. EMC STANDARDS / 電磁相容性標準

8.1 EMI STANDARDS / EMI 標準

The power supply met the radiated and conducted emission requirements for FCC CLASS B, EN55032 CLASS B.

本充電器符合輻射及傳導要求，滿足FCC CLASS B, EN55032 CLASS B.

8.2 EMS STANDARDS / EMS 標準

The power supply shall meet the following EMS standards:

本充電器滿足下列EMS標準

EDITION	A	PAGE	5/10
----------------	----------	-------------	-------------

ELECTRICAL PERFORMANCE / 電器性能

- 8.2.1 EN61000-4-2: 2009 / A1: 1998 Electrostatic Discharge(ESD)
8.2.2 EN61000-4-3: 2010 / A1: 1998 Radiated Electromagnetic Fields(RS)
8.2.3 EN61000-4-4: 2012 Electrical Fast Transient / Burst(EFT)
8.2.4 EN61000-4-5: 2014 Lighting Surge Attachment. Line to Neutral: 1.75KV

9.RELIABILITY AND QUALITY CONTROL / 可靠性及品質控制

9.1 **BURN—IN / 老化** The power supply shall undergo a minimum of 4 hours Burn—In test under full load at **40°C~±5°C**. 充電器應在**40°C~±5°C**和滿載條件下老化**4**小時。

9.2 **COMPONENT DERATING / 元件溫度要求** Semiconductor junction temperatures shall not exceed the manufacturer's maximum thermal rating.半導體結溫不允許超過其製造商要求的最大溫度值。

IELECTRIC WITHSTANDING STRENGTH(HI-POT) / 絕緣介電強度 (耐壓)

9.3 **Primary to Secondary AC3000V, 10mA,1 minute for type test, 3 second for production.**
一次側對二次側：**AC3000V, 10mA**標準測試**1**分鐘，量產測試**3**秒鐘。

10.WEIGHT / 重量 The weight of the power supply shall be about **800 g**.. 充電器的重量大約為**800 g**

11.MECHANICAL REQUIREMENT / 結構參數

The power supply size: **L167.8*W65.9*H33.3mm**.外殼尺寸：**L167.8*W65.9*H33.3mm**

12 **INSULATION RESISTANCE / 絕緣阻抗** Input to output: **50M OHM(500VDC)**輸入對輸出**50兆歐姆(500VDC)**

13.LEAKAGE CURRENT / 漏電流

The leakage current shall be **less than 0.25mA for class II**when power supply is operated maximum input voltage and maximum load. 當充電器操作在最大輸入及最大負載情況下，其漏電流應小於**0.25mA**，滿足**classII**等級。

14.MAJOR MEASURE EQUIPMENT / 主要測量設備; VERIFIED BY THE THIRD LAB/外校

- | | | | |
|---|--|--------------------------|---|
| A | AC SOURCE / AC變頻電源：固緯/GWINSTEK APS-7100E,校準頻次：1次/年 | <input type="checkbox"/> | ✓ |
| B | DIGITAL POWER METER / 數字功率計功率儀：固緯/GWINSTEK GPM-8213,校準頻次：1次/年 | <input type="checkbox"/> | ✓ |
| C | ELECTRONIC LOAD / 開編程電子負載儀：美爾諾/MAYNUO M9713,校準頻次：1次/年 | <input type="checkbox"/> | ✓ |
| D | OSCILLOSCOPE / 存儲示波器：泰科/TEKTRONIX TBS1102B,校準頻次：1次/年 | <input type="checkbox"/> | ✓ |
| E | DIGITAL MULTIMETER / 數字式萬用表：福祿克(FLUKE) F12E+校準頻次：1次/年 | <input type="checkbox"/> | ✓ |
| F | DC POWER / 直流電源：麥創 (MATRIX) MPS-6030D校準頻次：1次/年 | <input type="checkbox"/> | ✓ |
| G | HIPOT AND INSULATION RESISTANCE TESTER / 耐壓安規測試儀：
固緯/GWINSTEK GPT-9803 ,校準頻次：1次/年 | <input type="checkbox"/> | ✓ |
| H | NSULATION RASISTANCE TESTER / 絕緣電阻表：YD2681A,校準頻次：1次/年 | <input type="checkbox"/> | ✓ |
| I | MULTI CHANNEL TEMPERATURE SENSOR / 多路溫度測試儀
艾維泰科/IVYTECH IV380-16校準頻次：1次/年 | <input type="checkbox"/> | ✓ |

EDITION	A	PAGE	6/10
---------	---	------	------

PRODUCT OUTLINE DIMENSION / 產品外觀尺寸(mm)

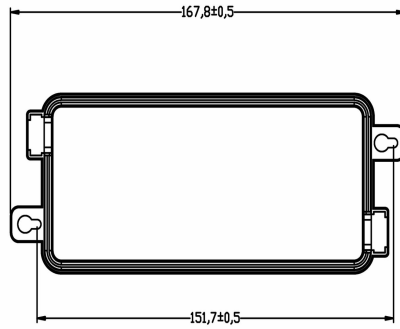
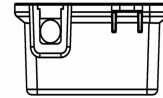
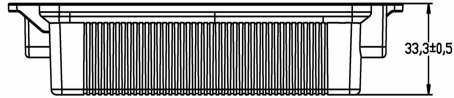
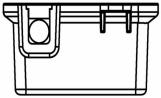
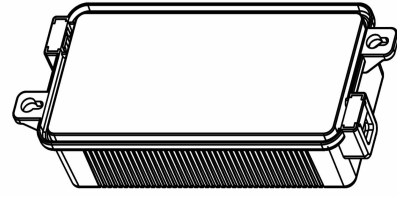
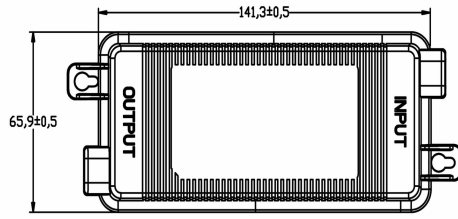

Material/材料: PC

Brand/品牌: SABIC / 沙伯

Fireproof Class/防火等級: UL94V-0

Color/顏色: Black/黑色

EDITION	A	PAGE	7/10
---------	---	------	------

AC CORD / 輸入線材

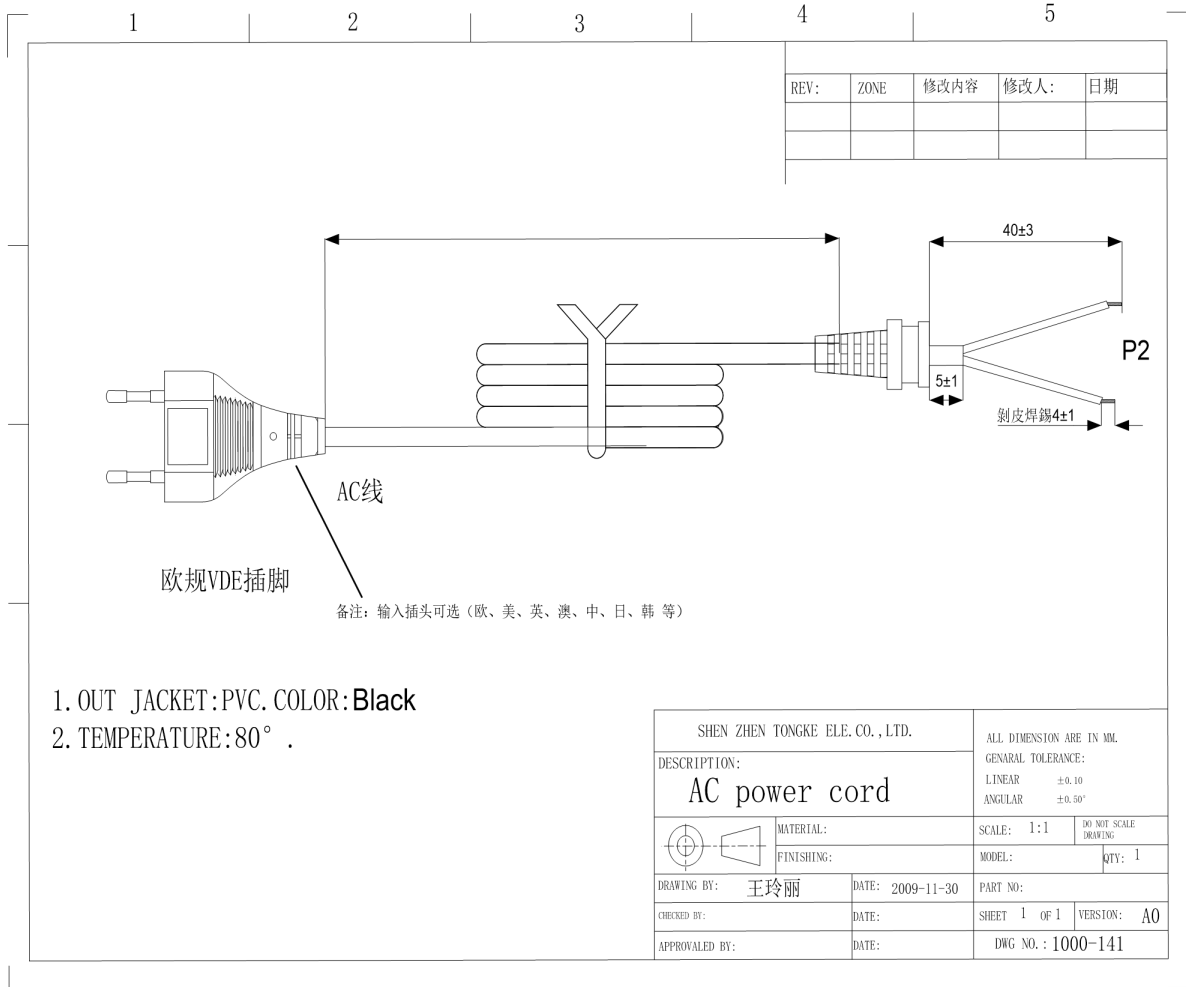

EDITION	A	PAGE	8/10
----------------	----------	-------------	-------------

DC CORD / 輸出線材

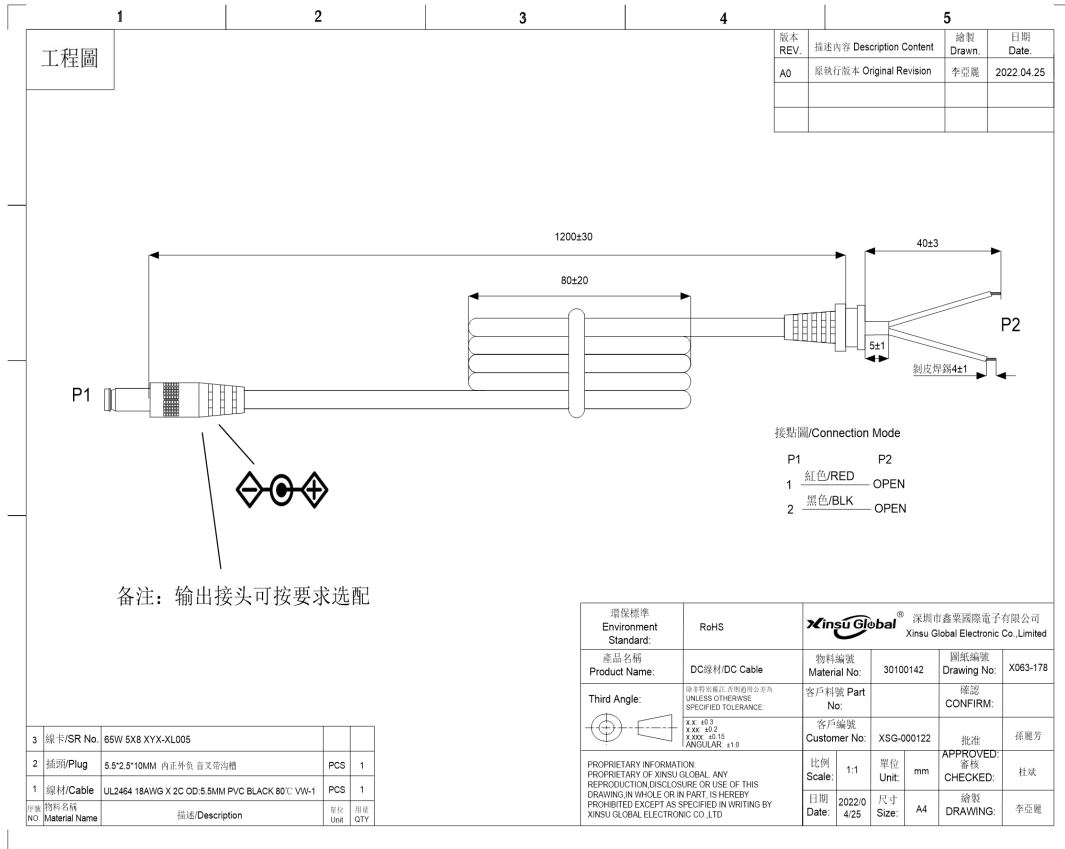

Cable Specification/線材規格		
UL2464 Round Wire, 20AWG*2C L=1.2M Black 80°C,300V		
Item No	Part Name (部件名稱)	Description (描述)
A	Length of DC cord(DC線長度)	1200MM
B	Size of DC connector (DC頭尺寸)	5.5*2.5*10MM, 內正外負, 直頭 (可选)
C	Length of coil (線包長度)	80MM±5
D	SR NO(線卡編號)	XYX-XL005
E	Stripped length(剝皮長度)	40MM±1mm
F	Tinned length (吃錫長度)	4MM±1mm

EDITION	A	PAGE	9/10
----------------	----------	-------------	-------------

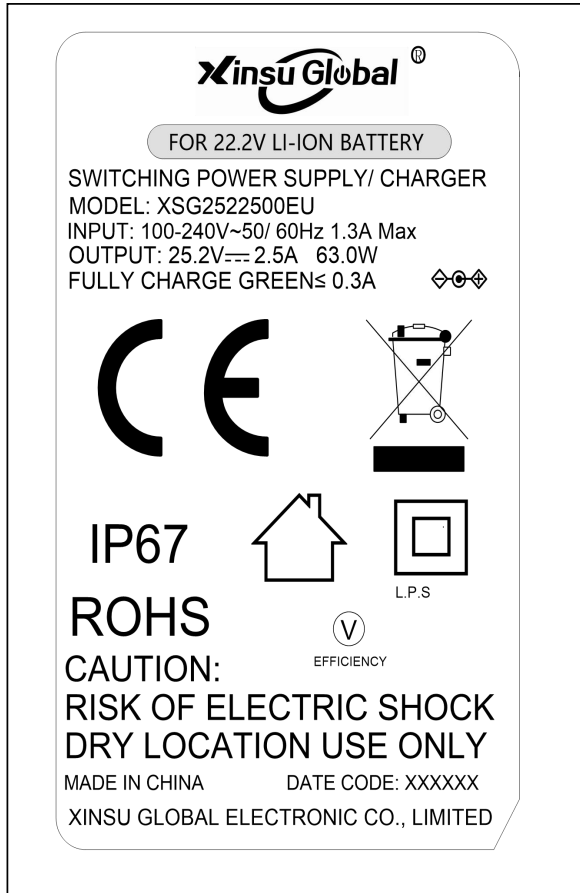

Print/印刷

Laser Carving/鐫雕

- 1.Silver text on black background 黑底銀字
- 2.Material: PET 底材為消銀龍.
3. Clear Printing, Wipe Resistance 絲印清晰, 耐擦拭,product packaging
- 4.Gum Permanent 永久背膠.
- 5.Meet Requirements of Environmental Protection 符合環保要求

EDITION	A	PAGE	10/10
---------	---	------	-------